

N32H473xC/xE/xG

Product Brief

N32H473 series adopts a 32-bit ARM Cortex-M4F core, with a maximum operating frequency of 200MHz, supporting floating-point unit and DSP instructions. It integrates up to 512-KB embedded P-Flash, 512KB D-FLASH (supported by some models), 192-KB SRAM (including 32-KB CCM SRAM), and 4-KB Backup SRAM. It also integrates 4x 12bit 4.7Mps ADCs, 8x 12bit DAC, 4x PGA, 7x COMP, USB FS Device, U(S)ART, I2C, SPI, CAN-FD, Ethernet, and other communication interfaces. It supports FEMC, xSPI high-speed storage interfaces, I2S audio interface, multiple advanced control timers, general timers, basic timers, low-power timers. It also features a built-in hardware acceleration engine for cryptographic algorithms, supporting AES/TDES, SHA, MD5 algorithms, TRNG true random number generator, and CRC16/32.

Key Feature

- **CPU Core**
 - 32-bit ARM Cortex-M4F + FPU, single-cycle hardware multiplication and division instruction, support DSP instruction and MPU
 - Built-in 8-KB instruction Cache supporting Flash acceleration unit for zero-wait program execution
 - Frequency up to 200 MHz, 250 DMIPS
- **Memories**
 - 512-KByte of embedded P-Flash memory with ECC
 - ◆ Supports encryption, multi-user partition and data protection
 - ◆ 100,000 erase/write cycles and 10-years data retention
 - 512KB D-Flash (only supported by N32H473CGQ8), optional support for encrypted storage, 200,000 erase/write cycles
 - 160-KByte of general SRAM with hardware parity checking
 - 32-KByte of CCM SRAM with ECC, defaults to general SRAM after power-up, configurable as CCM SRAM
 - 4-KByte of Backup SRAM with ECC available in Standby mode
- **Power Modes**
 - Run mode: 45 mA/MHz@200 MHz (peripherals off, 3.3 V@25°C)
 - Stop0 mode: SRAM and all registers can be configured to retention, RTC run
 - Standby mode: typical value 6uA, all backup registers and Backup SRAM retained, all IOs retained, optional RTC run
- **Clock**
 - HSE: 4MHz~32MHz high-speed external crystal oscillator
 - LSE: 32.768KHz low-speed external crystal oscillator
 - Built-in multiple high speed PLLs
 - MCO: Supports 2-channel clock outputs, which can be configured independently as clock output
 - HSI: High-speed internal RC 8MHz, with an accuracy of -1.5% to +2% across the full temperature range.
 - LSI: Low-speed internal RC 32KHz, with an accuracy of +/-10% across the full temperature range.
- **Reset**
 - Supports power-on/brown-out/external pin reset
 - Supports watchdog reset
 - Supports programmable voltage detection
- **GPIOs**
 - Up to 107 GPIOs

- **Communication Interfaces**

- 1x USB2.0 FS Device interface, built-in PHY, supports crystal-less mode
- 6x SPI interfaces, 2x I2S interfaces, support half/full duplex mode, multiplexed with SPI interfaces
- U(S)ART interfaces
 - 4x USART interfaces (support ISO7816, IrDA, LIN)
 - 4x UART interfaces
 - TX/RX of USART3/UART5/UART8 can be mapped to all pins
- 4x I2C interfaces(Master/Slave) with speed up to 1 MHz where slave mode support dual address response
- 2x CAN-FD bus interface, TX/RX can be mapped to all pins

- **High Performance Analog Interfaces**

- 4x 12bit ADCs with 4.7Msps
 - Multiple precision configuration, support 12-bit, 10-bit, 8-bit, 6-bit sampling precision, resolution up to 16-bit with hardware oversample
 - Up to 16 external single-ended input channels, 3 internal single-ended input channels, support differential mode and single-ended mode
- 8x 12bit DAC
 - DAC1~4: Support 1 internal output channel and 1 external output channel, with a sampling rate of 1Msps. Support output channel buffered/unbuffered modes.
 - DAC5~8: Support 1 internal output channel and 1 external output channel, with a sampling rate of 15Msps. Only support output channel buffered/unbuffered modes.
- 4x rail-to-rail PGAs, support differential mode and single-ended mode
- 7x high-speed comparators (COMP)

- **High Speed External Memory Interfaces**

- 1x xSPI interface, supporting external SRAM, PSRAM and Flash, supporting XIP
- 1x FEMC (Flexible External Memory Controller) interface, supporting external SRAM, PSRAM, NOR Flash and NAND Flash, 8/16-bit data bus width configurable

- **CORDIC Mathematical hardware accelerator for motor control functions**

- **Built-in filter mathematical accelerator FMAC, supporting FIR, IIR filtering**

- **DMA Controllers**

- 2x DMA controller
- Each controller supports 8 channels
- Channel source address and destination address can be configured arbitrarily

- **RTC real-time clock**

- Supports leap-year calendar, alarm event, periodic wake up
- Supports internal and external clock calibration
- **Timers**
 - 3x 16-bit advanced control timers with maximum control precision of 5 ns
 - Support input capture, complementary output, quadrature encoder input etc.
 - Each has 6 independent channels, 4 of which support 4 pairs of complementary PWM output.
 - 10x 16-bit general purpose timers (GTIM1~10)
 - GTIM1~7, with a maximum control precision of 5.56ns, each timer has up to 4 independent channels, each channel supports input capture, output comparison, PWM generation, and single-pulse mode output.
 - GTIM8~10, with a maximum control precision of 5ns, each timer has up to 4 independent channels, each channel supports input capture, output comparison, PWM generation, and single-pulse mode output, only channel 1 supports complementary output with dead time, supports break input.
 - 2x 32-bit basic timers
 - 2x 16-bit low-power timer, can operate in Stop0 and Standby mode.
 - 1x 24-bit SysTick timer.
 - 1x 14-bit Window Watchdog (WWDG)
 - 1x 12-bit Independent Watchdog (IWDG)
- **Programming Methods**
 - Support SWD/JTAG debugging interface.
 - Support UART and USB Bootloader
- **Security Features**
 - Flash encryption, multi-user partition management unit (SMPU)
 - Supports write protection (WRP), multiple read protection (RDP) levels (L0/L1/L2)
 - Built-in hardware acceleration engine for cryptographic algorithm
 - Supports AES/TDES, SHA, and MD5 algorithms
 - True random number generator(TRNG)
 - CRC16/32 operation
 - Supports secure boot, program encryption download, secure firmware update
 - Supports external clock failure detection, anti-tamper detection.
- **96-bit UID and 128-bit UCID**
- **Operating Conditions**
 - Operating voltage range: 1.8V~3.6V
 - Operating temperature range: -40°C ~ 105°C/125°C

- ESD: ±4KV (HBM model), ±1KV (CDM model)
- EFT: EFT: VDD (+/-4KV, level A), I/O (+/-2KV, level A)

● **Packages**

- UQFN32(5mm x 5mm)
- QFN48(7mm x 7mm)
- UQFN48(7mm x 7mm)
- UQFN48-1(7mm x 7mm)
- LQFP48(7mm x 7mm)
- LQFP64(10mm x 10mm)
- LQFP80(12mm x 12mm)
- LQFP100(14mm x 14mm)
- LQFP128(14mm x 14mm)

● **Ordering Information**

Reference	Part Number
N32H473xC	N32H473KCU7, N32H473CCU7, N32H473CCU7E N32H473CCL7, N32H473RCL7, N32H473MCL7, N32H473VCL7, N32H473QCL7 N32H473KCU8, N32H473CCU8 N32H473CCL8, N32H473RCL8, N32H473MCL8, N32H473VCL8, N32H473QCL8
N32H473xE	N32H473KEU7, N32H473CEU7 N32H473CEL7, N32H473REL7, N32H473MEL7, N32H473VEL7, N32H473QEL7 N32H473KEU8, N32H473CEU8 N32H473CEL8, N32H473REL8, N32H473MEL8, N32H473VEL8, N32H473QEL8
N32H473xG	N32H473CGQ8

1 Ordering Information

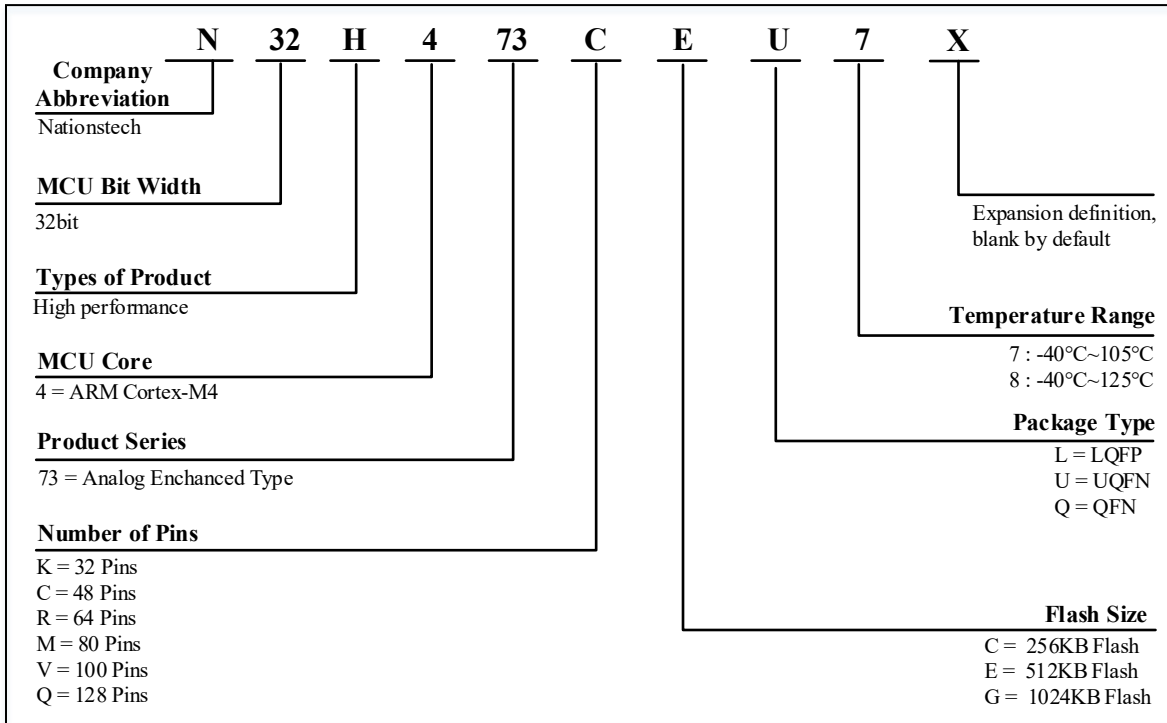

Table 1-1 N32H473 Series Ordering Code

Ordering Code ⁽¹⁾	Package	Size	Packaging ⁽²⁾	SPQ ⁽³⁾	Temperature range
N32H473KCU7	UQFN32	5mm x 5mm	Tray	490	-40°C~105°C
N32H473CCU7	UQFN48	7mm x 7mm	Tray	260	-40°C~105°C
N32H473CCU7E	UQFN48-1	7mm x 7mm	Tray	260	-40°C~105°C
N32H473CCL7	LQFP48	7mm x 7mm	Tray	250	-40°C~105°C
N32H473RCL7	LQFP64	10mm x 10mm	Tray	160	-40°C~105°C
N32H473MCL7	LQFP80	12mm x 12mm	Tray	119	-40°C~105°C
N32H473VCL7	LQFP100	14mm x 14mm	Tray	90	-40°C~105°C
N32H473QCL7	LQFP128	14mm x 14mm	Tray	90	-40°C~105°C
N32H473KEU7	UQFN32	5mm x 5mm	Tray	490	-40°C~105°C
N32H473CEU7	UQFN48	7mm x 7mm	Tray	260	-40°C~105°C
N32H473CEL7	LQFP48	7mm x 7mm	Tray	250	-40°C~105°C
N32H473REL7	LQFP64	10mm x 10mm	Tray	160	-40°C~105°C
N32H473MEL7	LQFP80	12mm x 12mm	Tray	119	-40°C~105°C
N32H473VEL7	LQFP100	14mm x 14mm	Tray	90	-40°C~105°C
N32H473QEL7	LQFP128	14mm x 14mm	Tray	90	-40°C~105°C
N32H473KCU8	UQFN32	5mm x 5mm	Tray	490	-40°C~125°C

N32H473CCU8	UQFN48	7mm x 7mm	Tray	260	-40°C~125°C
N32H473CCL8	LQFP48	7mm x 7mm	Tray	250	-40°C~125°C
N32H473RCL8	LQFP64	10mm x 10mm	Tray	160	-40°C~125°C
N32H473MCL8	LQFP80	12mm x 12mm	Tray	119	-40°C~125°C
N32H473VCL8	LQFP100	14mm x 14mm	Tray	90	-40°C~125°C
N32H473QCL8	LQFP128	14mm x 14mm	Tray	90	-40°C~125°C
N32H473KEU8	UQFN32	5mm x 5mm	Tray	490	-40°C~125°C
N32H473CEU8	UQFN48	7mm x 7mm	Tray	260	-40°C~125°C
N32H473CEL8	LQFP48	7mm x 7mm	Tray	250	-40°C~125°C
N32H473REL8	LQFP64	10mm x 10mm	Tray	160	-40°C~125°C
N32H473MEL8	LQFP80	12mm x 12mm	Tray	119	-40°C~125°C
N32H473VEL8	LQFP100	14mm x 14mm	Tray	90	-40°C~125°C
N32H473QEL8	LQFP128	14mm x 14mm	Tray	90	-40°C~125°C
N32H473CGQ8	QFN48	7mm x 7mm	Tray	260	-40°C~125°C

1. For the latest detailed-ordering information, please refer to the Selection Guide.
2. The packaging provided is the basic packaging. If user has any other requirements, please contact Naitons.
3. Minimum packaging quantity.

2 Product Configurations

Table 2-1 N32H473 Series Product Configuration

Device	N32H473KCU7/8 N32H473KEU7/8	N32H473CGQ8	N32H473CCU7/8 N32H473CEU7/8 N32H473CCU7E	N32H473CCL7/8 N32H473CEL7/8	N32H473RCL7/8 N32H473REL7/8	N32H473MCL7/8 N32H473MEL7/8	N32H473VCL7/8 N32H473VEL7/8	N32H473QCL7/8 N32H473QEL7/8								
Operating Condition	1.8~3.6V/-40~105°C /125°C															
CPU Frequency	ARM Cortex-M4F @200MHz, 250DMIPS															
P-Flash Capacity (KB)	256	512	512	256	512	256	512	256	512	256	512	256	512	256	512	
D-Flash Capacity (KB)	No	No	512 ⁽⁵⁾	No	No	No	No	No	No	No	No	No	No	No	No	
Total SRAM (KB)	General SRAM	112	160	160	112	160	112	160	112	160	112	160	112	160	112	160
	CCM SRAM	32 ⁽¹⁾														
	Backup SRAM	4														
Times	ATIM	3*16bit														
	GTIM	7*16bit 3*16bit ⁽²⁾														
	BTIM	2*32bit														
	LPTIM	2*16bit														
	SysTick timer	1														
	WWDG	1*14bit														
	IWDG	1*12bit														
	RTC	Yes														
Communication	SPI/I2S	4/2	5/2									6/2				
	I ² C	4														
	USART	4														
	UART	4														
	USB FS Device	Yes														
	FDCAN	2														
Memory Expansion	XSPI	Yes ⁽³⁾									Yes					
	FEMC	No										Yes ⁽⁴⁾		Yes		
GPIO WKUP Pins	26	42				37		52		66		86		107		
	2	3				3		4		4		5		5		
DMA Number of channels	2 16 Channel															
12bit ADC Number of channels	4 13Channel	4 21Channel				4 20Channel		4 26Channel		4 38Channel		4 45Channel		4 51Channel		

12bit DAC Number of channels	8 8 (4 External/Internal + 4 Internal)							
PGA	4							
COMP	7							
VREFBUF	No	Yes						
Algorithm Support	DES/3DES、AES、SHA1/SHA224/SHA256, MD5, CRC16/CRC32							
TRNG	Yes							
Cordic	Yes							
FMAC	Yes							
Security Protection	Read-write protection (RDP/WRP), storage encryption, partition protection, secure boot							
Package	UQFN32	QFN48	UQFN48/UQFN48-1	LQFP48	LQFP64	LQFP80	LQFP100	LQFP128

Notes:

- (1) CCM SRAM is powered up as general SRAM by default, and users can configure it as CCM SRAM.
- (2) Support for brakes, channel 1 supports complementary channel outputs.
- (3) XSPI does not support 8-wire mode.
- (4) FMEC only supports address bus and data bus multiplexing.
- (5) N32H473CGQ8 internal D-FLASH uses the XSPI interface, occupying pins PG8-CS, PF1-CLK, PG12-IO0(DO), PF8-IO1(DI), PF4-IO2(WP), PF5-IO3(HOLD#)

3 Package

3.1 UQFN32

3.1.1 UQFN32 Pinout

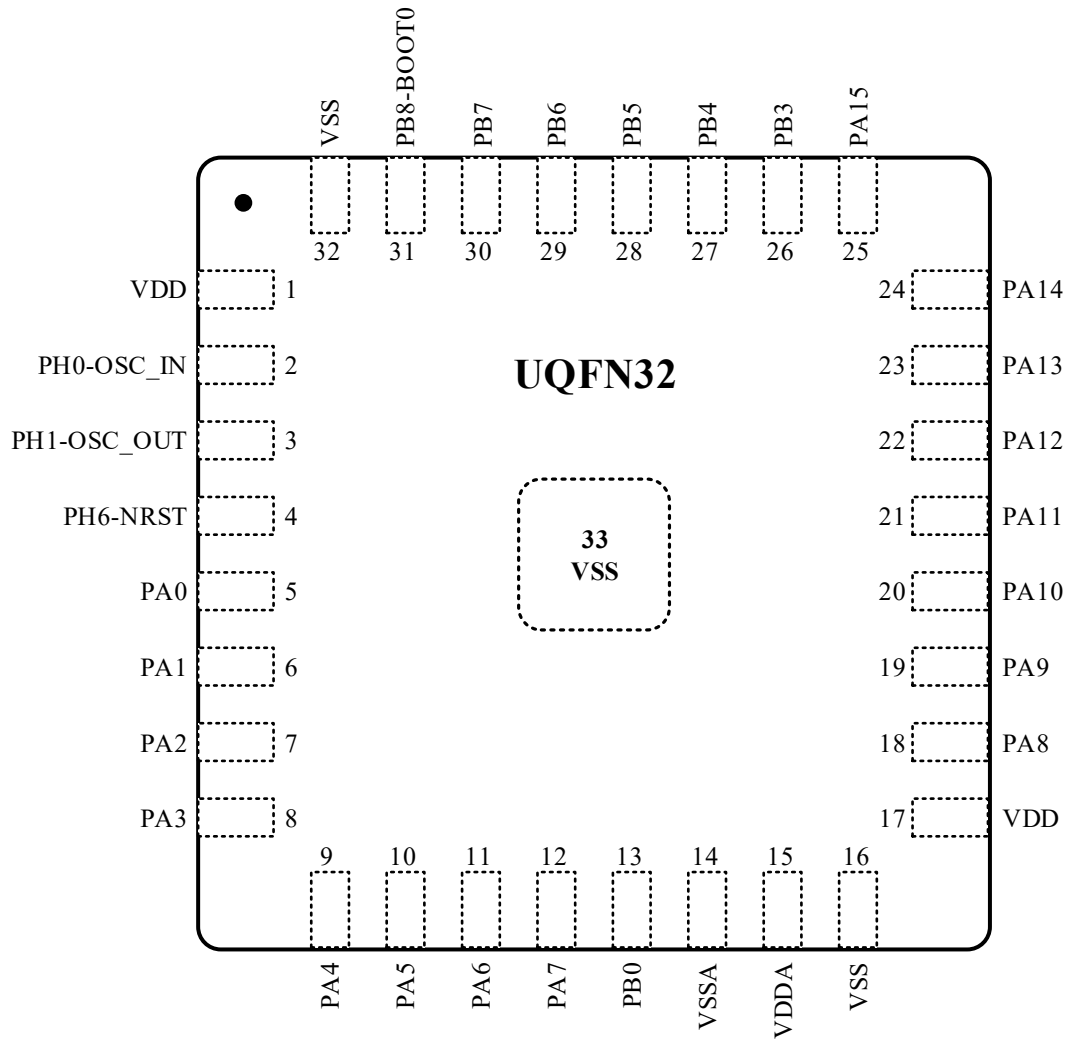

3.1.2 UQFN32 Package

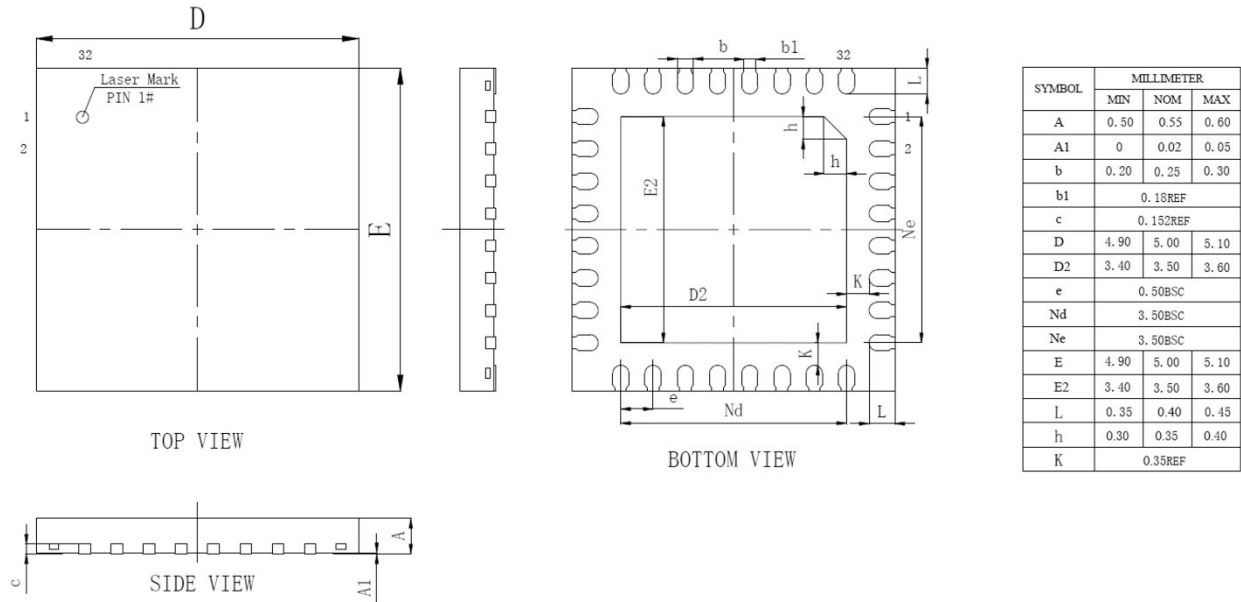

Symbol	millimeters			inches ⁽¹⁾		
	Min	Typ	Max	Min	Typ	Max
A ⁽²⁾	0.500	0.550	0.600	0.0197	0.0217	0.0238
A1	0	0.020	0.050	0	0.0008	0.0020
A3	-	0.152	-	-	0.0060	-
b	0.180	0.250	0.300	0.0071	0.0098	0.0118
D ⁽³⁾	4.900	5.000	5.100	0.1929	0.1969	0.2008
D1	3.400	3.500	3.600	0.1339	0.1378	0.1417
E ⁽³⁾	4.900	5.000	5.100	0.1929	0.1969	0.2008
E1	3.400	3.500	3.600	0.1339	0.1378	0.1417
e	-	0.500	-	-	0.0197	-
L	0.300	0.400	0.500	0.0118	0.0157	0.0197
ddd	-	-	0.080	-	-	0.0031

1. Values in inches are converted from mm and rounded to 4 decimal digits.
2. UFQFPN stands for thermally enhanced ultra thin fine pitch quad flat package no lead.
3. Dimensions D and E do not include mold protrusion (it cannot exceed 0,15 mm).

UFQFPN32 - Recommended footprint

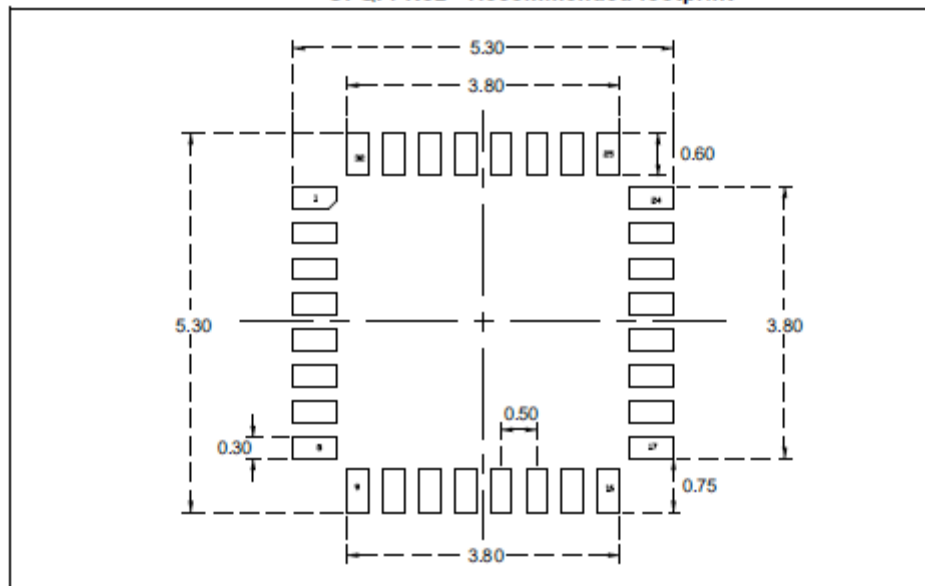

3.2 QFN48

3.2.1 QFN48 Pinout

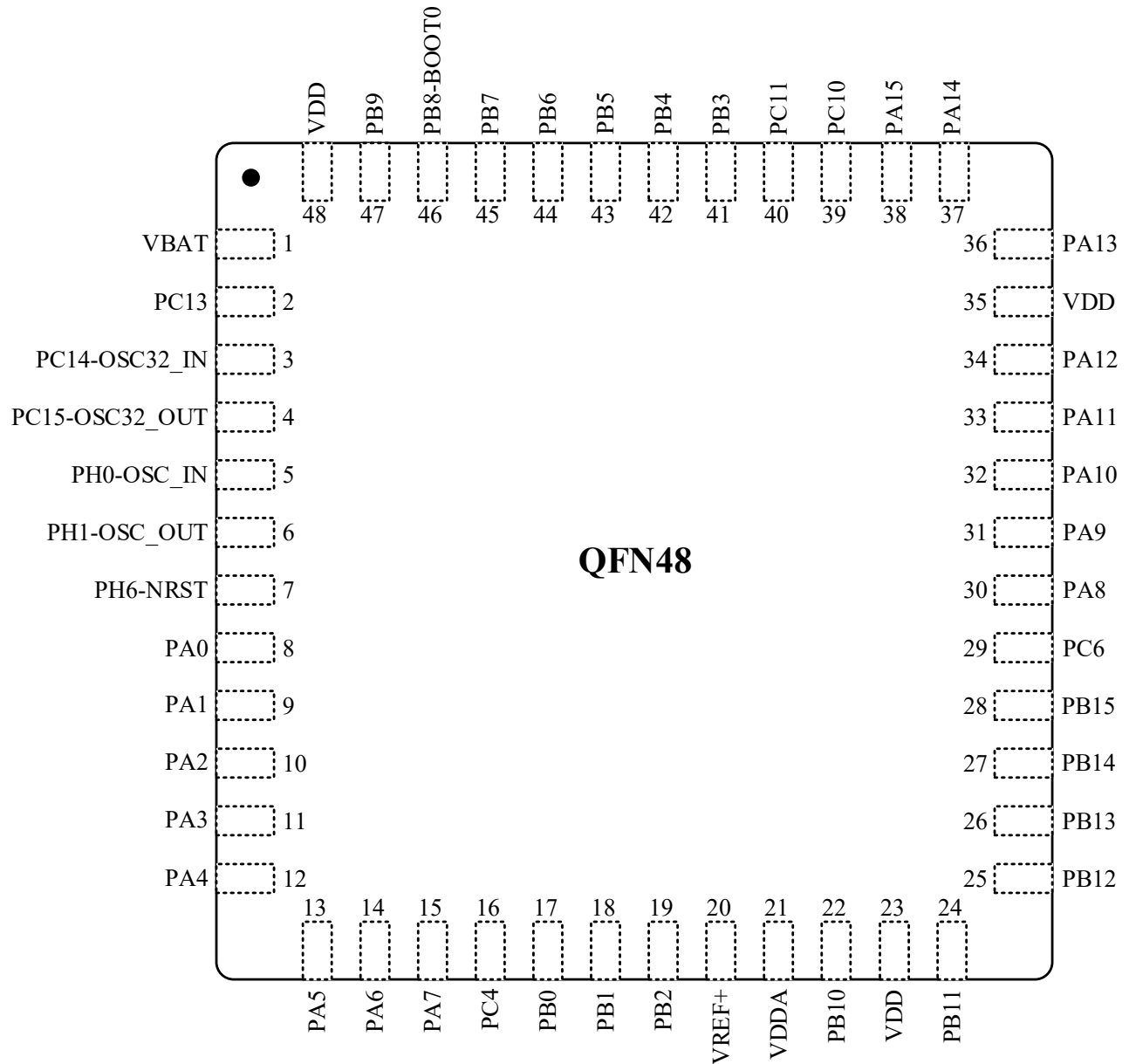

3.2.2 QFN48 Package

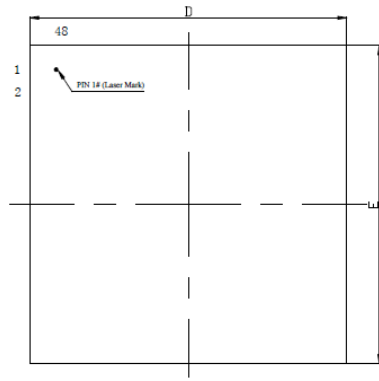

TOP VIEW

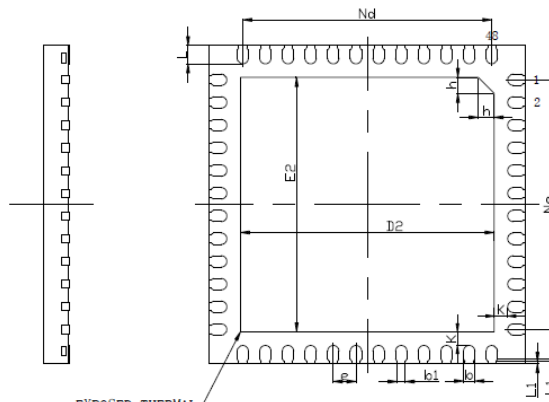

BOTTOM VIEW

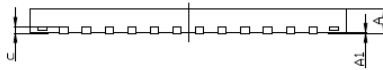

SIDE VIEW

SYMBOL	MILLIMETER		
	MIN	NOM	MAX
A	0.80	0.85	0.90
A1	0	0.02	0.05
b	0.20	0.25	0.30
b1	0.18REF		
c	0.152REF		
D	6.90	7.00	7.10
D2	5.50	5.60	5.70
Nd	5.50BSC		
e	0.50BSC		
E	6.90	7.00	7.10
E2	5.50	5.60	5.70
Ne	5.50BSC		
L	0.35	0.40	0.45
L1	0	0.05	0.10
K	0.30REF		
h	0.30	0.35	0.40

3.3 UQFN48

3.3.1 UQFN48 Pinout

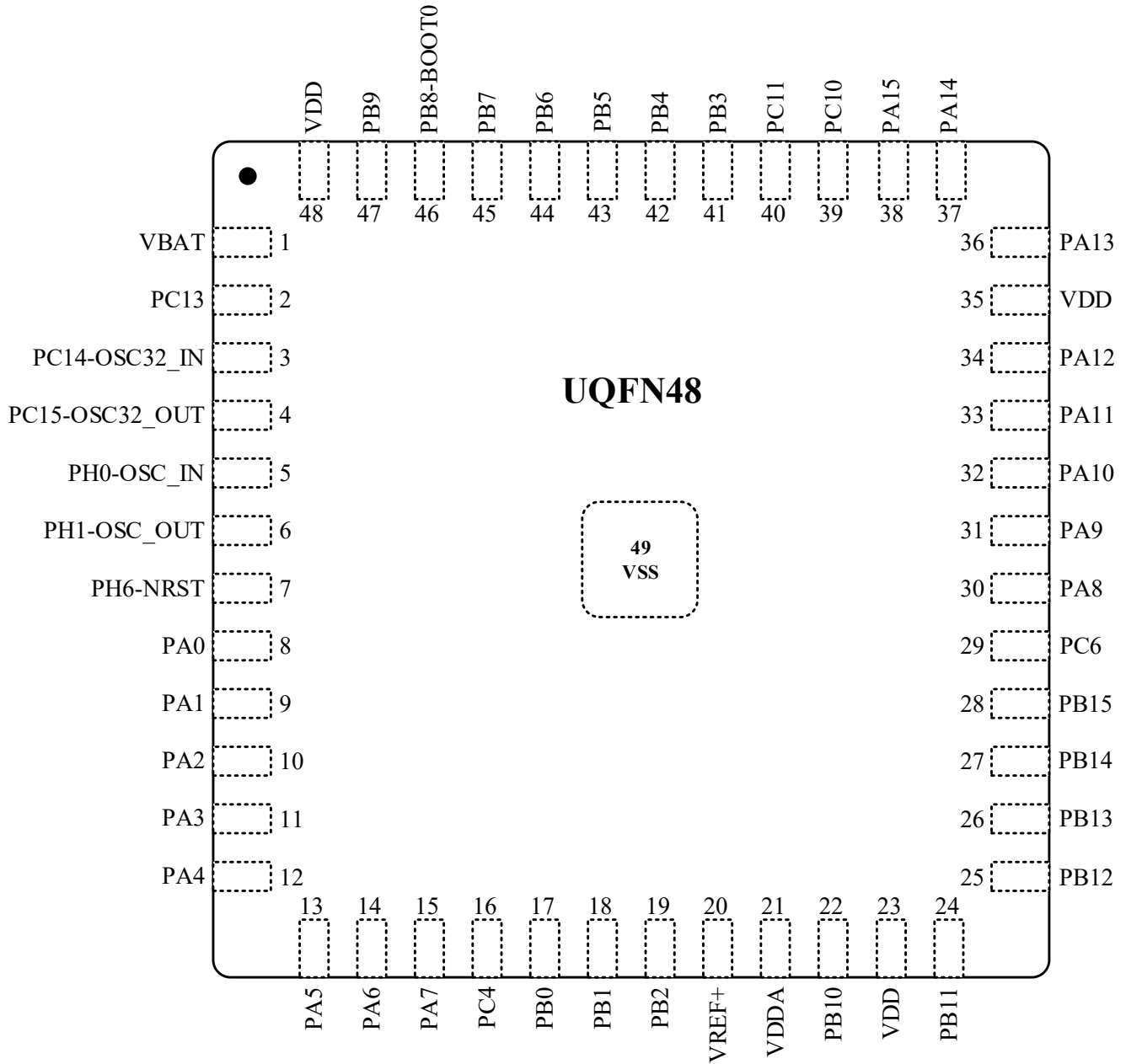

3.3.2 UQFN48 Package

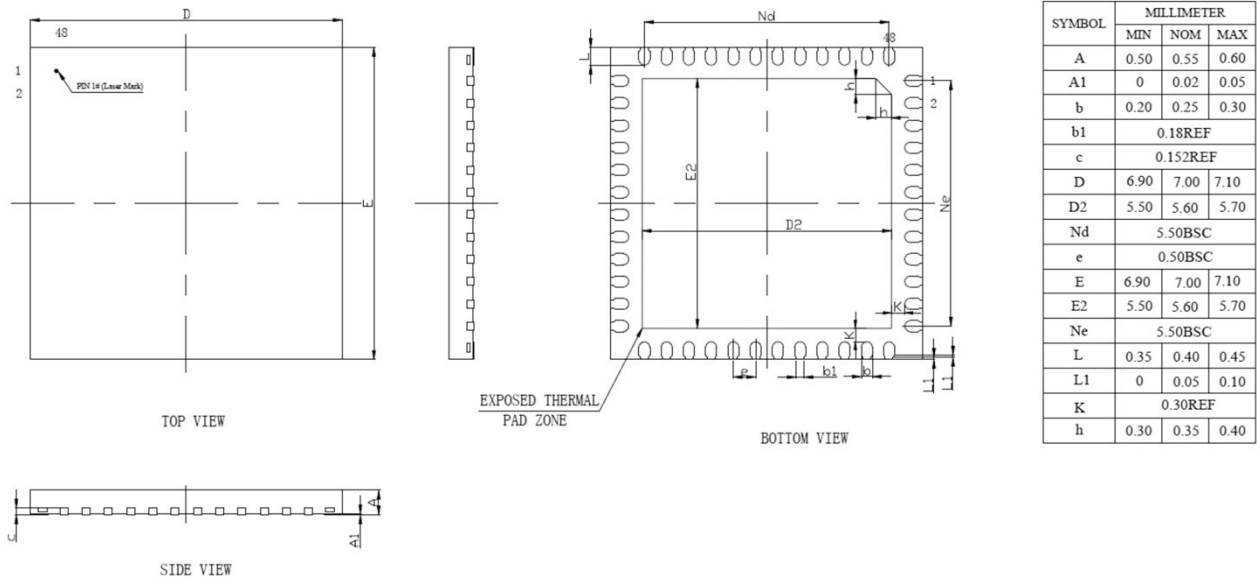

3.4 UQFN48-1

3.4.1 UQFN48-1 Pinout

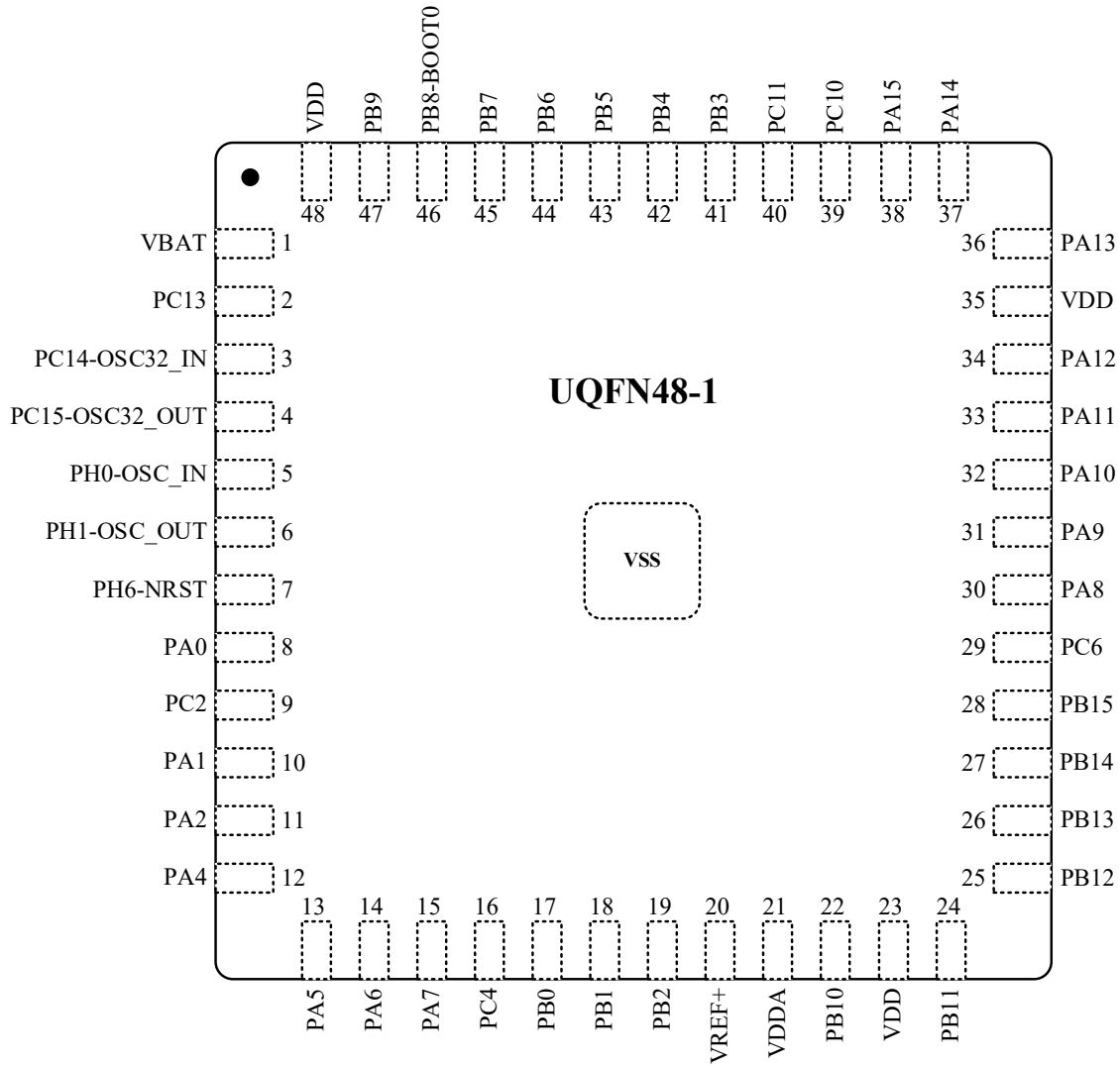

3.4.2 UQFN48-1 Package

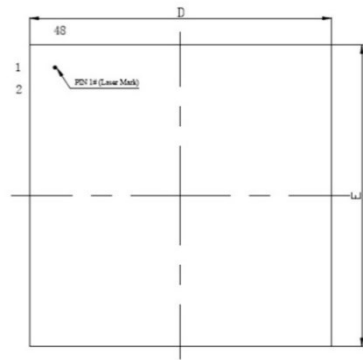

TOP VIEW

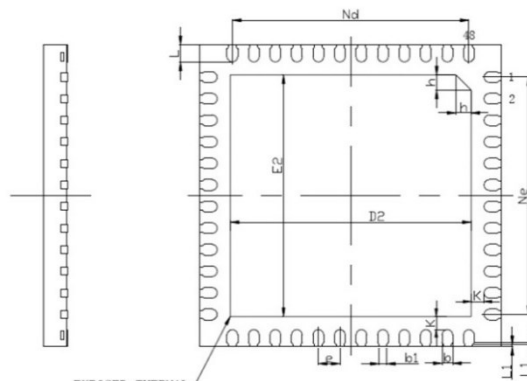

BOTTOM VIEW

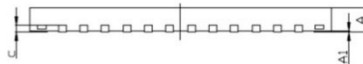

SIDE VIEW

SYMBOL	MILLIMETER		
	MIN	NOM	MAX
A	0.50	0.55	0.60
A1	0	0.02	0.05
b	0.20	0.25	0.30
b1	0.18REF		
c	0.152REF		
D	6.90	7.00	7.10
D2	5.50	5.60	5.70
Nd	5.50BSC		
e	0.50BSC		
E	6.90	7.00	7.10
E2	5.50	5.60	5.70
Ne	5.50BSC		
L	0.35	0.40	0.45
L1	0	0.05	0.10
K	0.30REF		
h	0.30	0.35	0.40

3.5 LQFP48

3.5.1 LQFP48 Pinout

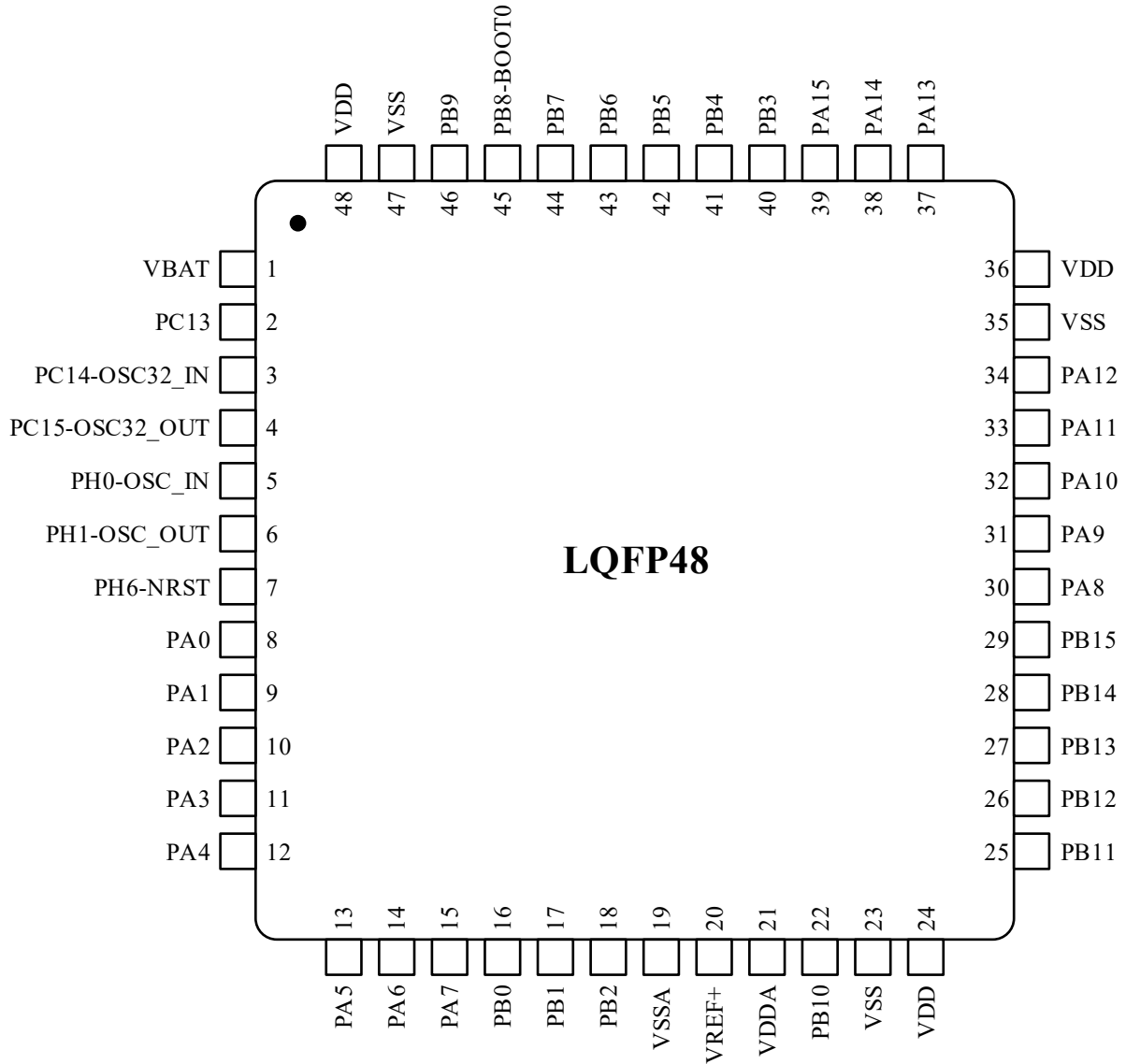

3.5.2 LQFP48 Package

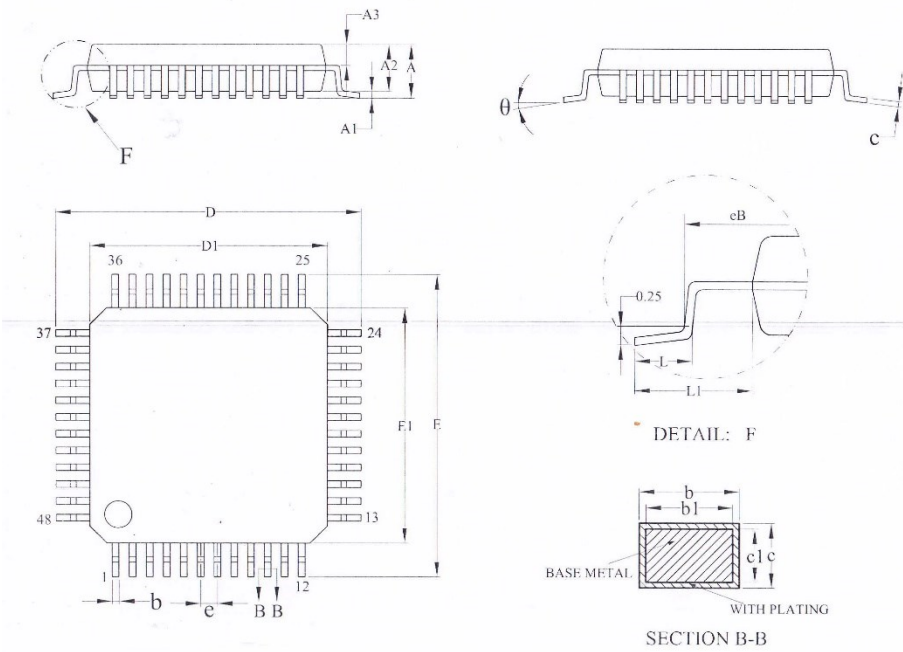

SYMBOL	MILLIMETER		
	MIN	NOM	MAX
A	—	—	1.60
A1	0.05	—	0.15
A2	1.35	1.40	1.45
A3	0.59	0.64	0.69
b	0.18	—	0.26
b1	0.17	0.20	0.23
c	0.13	—	0.17
c1	0.12	0.13	0.14
D	8.80	9.00	9.20
D1	6.90	7.00	7.10
E	8.80	9.00	9.20
E1	6.90	7.00	7.10
eB	8.10	—	8.25
e	0.50BSC		
L	0.45	—	0.75
L1	1.00REF		
0	0	—	7

3.6 LQFP64

3.6.1 LQFP64 Pinout

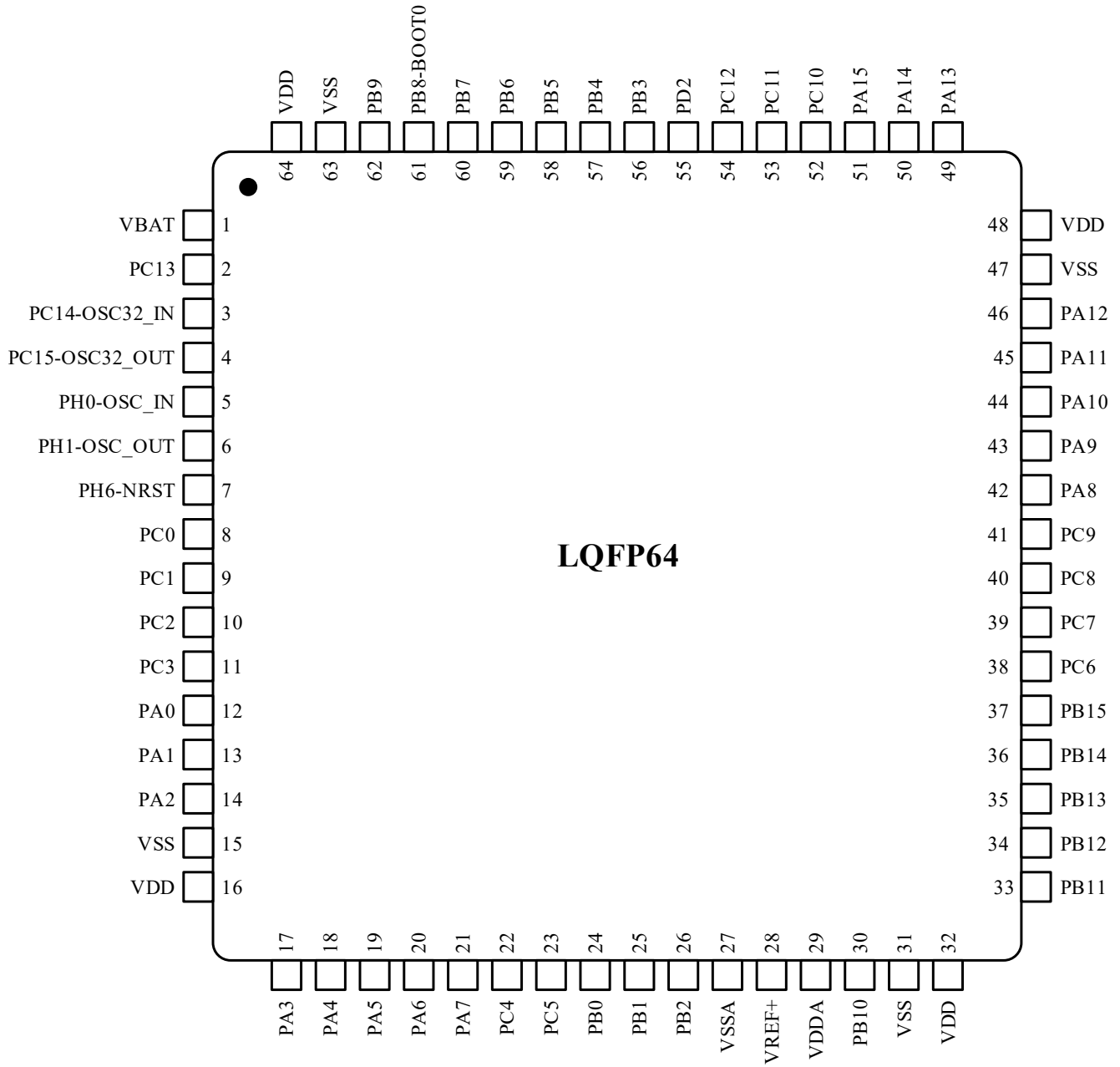

3.6.2 LQFP64 Package

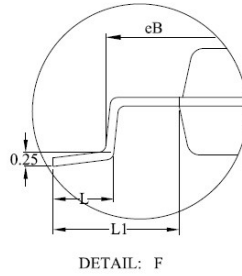
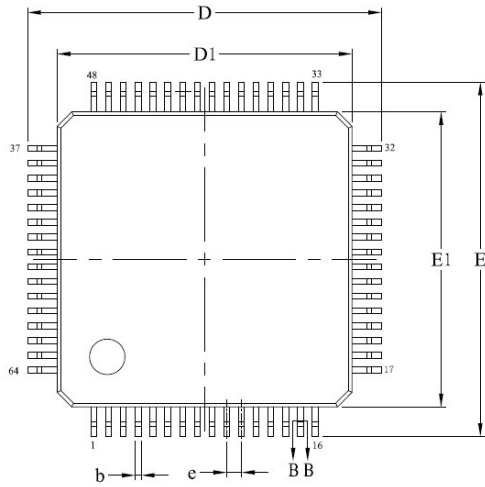
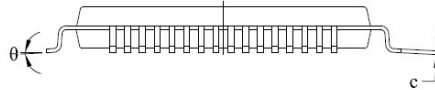
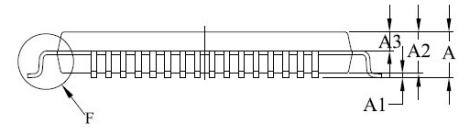

DETAIL: F

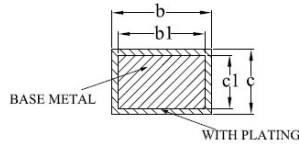

SECTION B-B

SYMBOL	MILLIMETER		
	MIN	NOM	MAX
A	—	—	1.60
A1	0.05	—	0.15
A2	1.35	1.40	1.45
A3	0.59	0.64	0.69
b	0.18	—	0.26
b1	0.17	0.20	0.23
c	0.13	—	0.17
c1	0.12	0.13	0.14
D	11.80	12.00	12.20
D1	9.90	10.00	10.10
E	11.80	12.00	12.20
E1	9.90	10.00	10.10
e	0.50BSC		
eB	11.05	—	11.25
L	0.45	—	0.75
L1	1.00REF		
θ	0	—	7°

3.7 LQFP80

3.7.1 LQFP80 Pinout

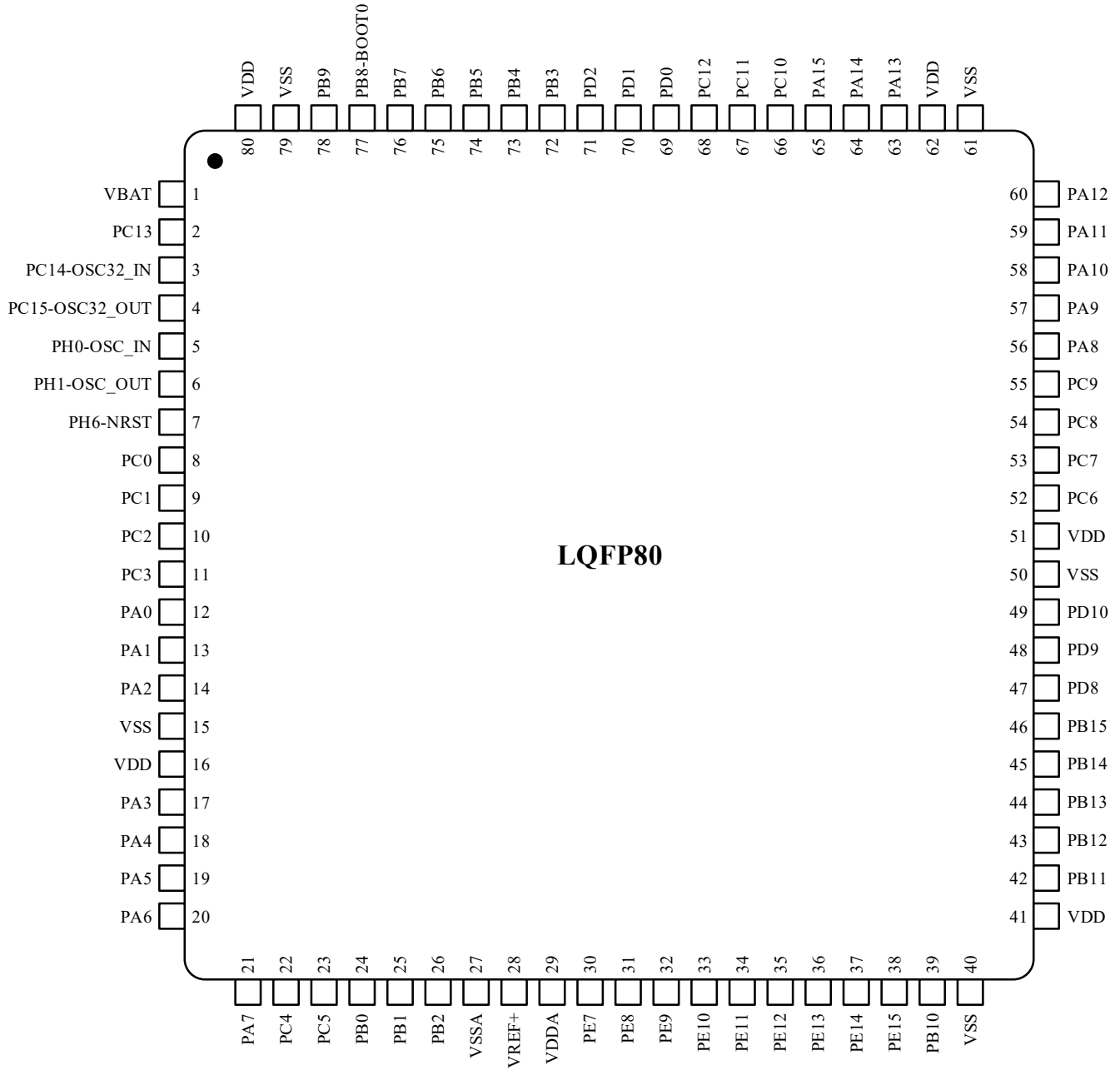

3.7.2 LQFP80 Package

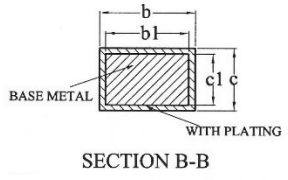
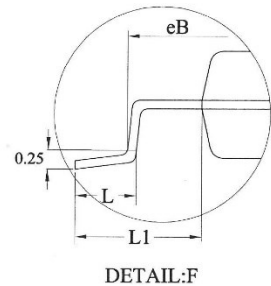
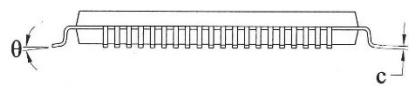
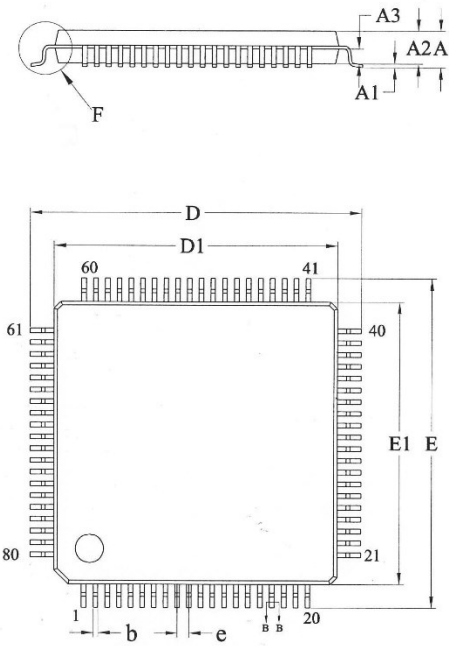

SYMBOL	MILLIMETER		
	MIN	NOM	MAX
A	—	—	1.60
A1	0.05	—	0.15
A2	1.35	1.40	1.45
A3	0.59	0.64	0.69
b	0.18	—	0.26
b1	0.17	0.20	0.23
c	0.13	—	0.17
c1	0.12	0.13	0.14
D	13.80	14.00	14.20
D1	11.90	12.00	12.10
E	13.80	14.00	14.20
E1	11.90	12.00	12.10
eB	13.05	—	13.25
e	0.50BSC		
L	0.45	0.60	0.75
L1	1.00REF		
θ	0	—	7°

3.8 LQFP100

3.8.1 LQFP100 Pinout

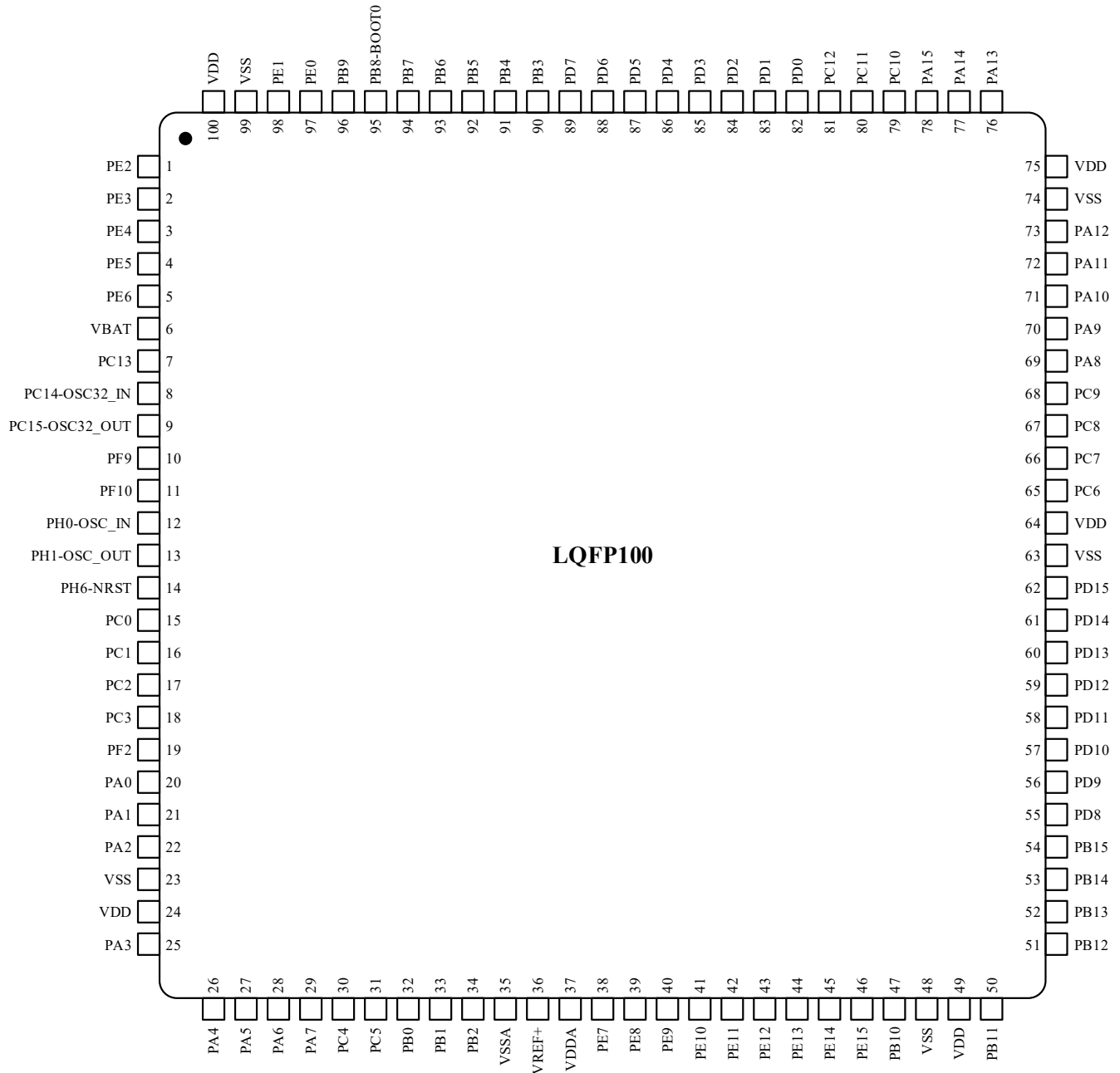

3.8.2 LQFP100 Package

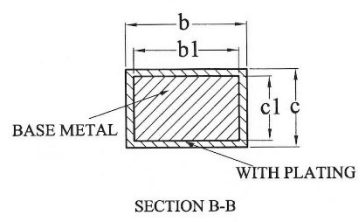
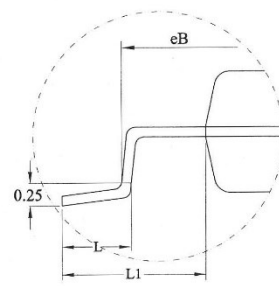
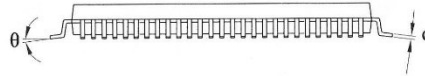
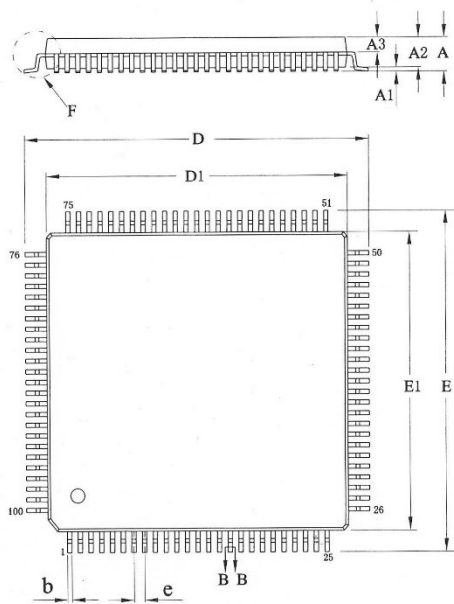

SYMBOL	MILLIMETER		
	MIN	NOM	MAX
A	—	—	1.60
A1	0.05	—	0.15
A2	1.35	1.40	1.45
A3	0.59	0.64	0.69
b	0.18	—	0.26
b1	0.17	0.20	0.23
c	0.13	—	0.17
c1	0.12	0.13	0.14
D	15.80	16.00	16.20
D1	13.90	14.00	14.10
E	15.80	16.00	16.20
E1	13.90	14.00	14.10
eB	15.05	—	15.35
e	0.50BSC		
L	0.45	—	0.75
L1	1.00REF		
θ	0	—	7°

3.9 LQFP128

3.9.1 LQFP128 Pinout

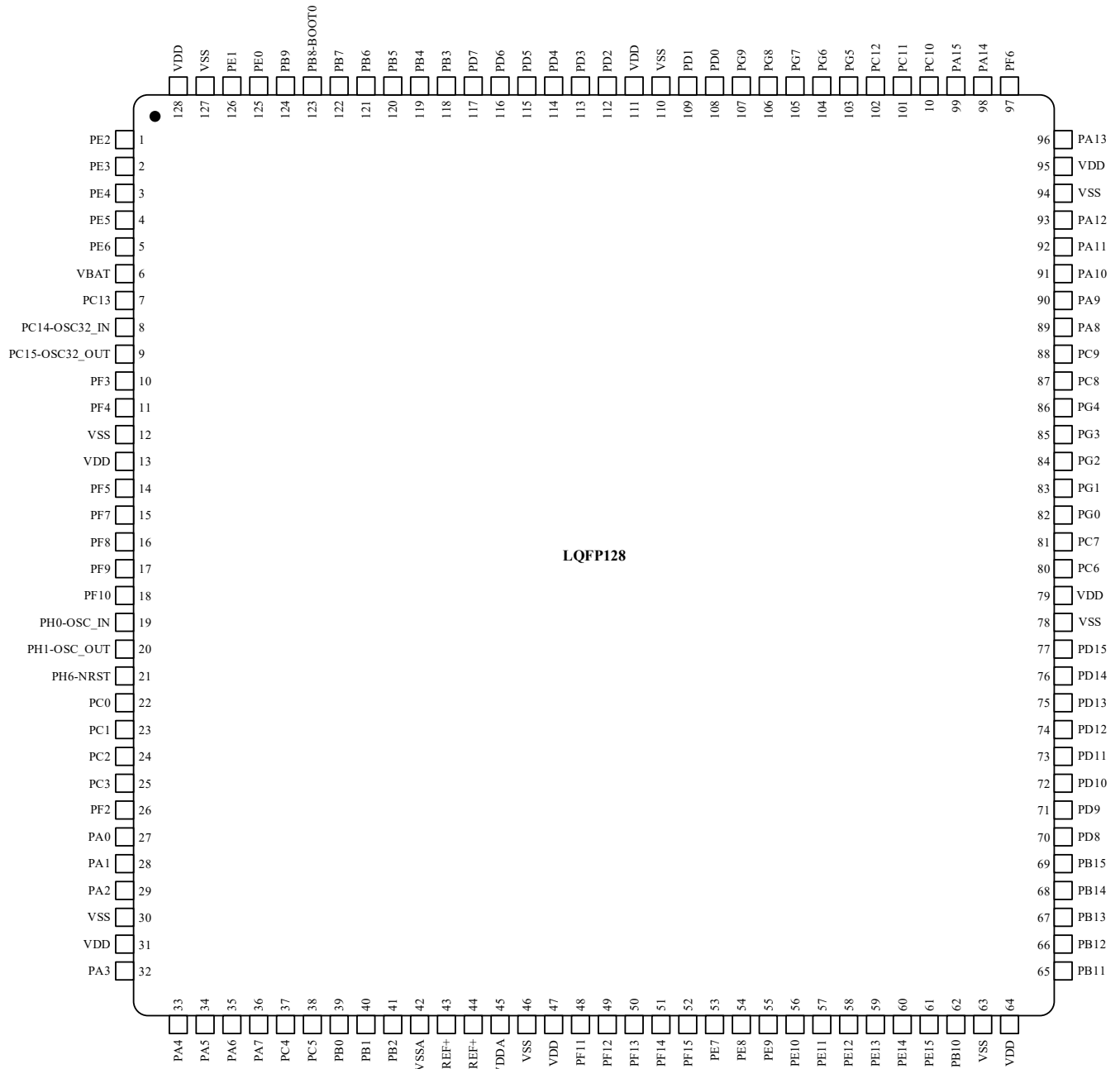

3.9.2 LQFP128 Package

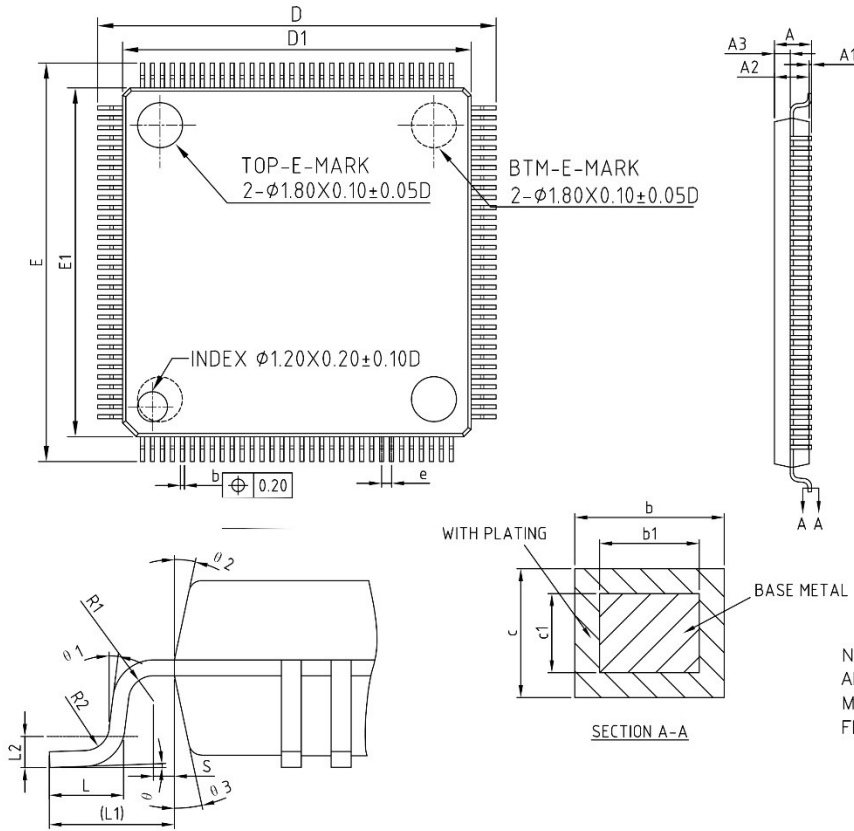

COMMON DIMENSIONS
(UNITS OF MEASURE=MILLIMETER)

SYMBOL	MIN	NOM	MAX
A	—	—	1.60
A1	0.05	—	0.15
A2	1.35	1.40	1.45
A3	0.59	0.64	0.69
b	0.14	—	0.23
b1	0.13	0.16	0.19
c	0.13	—	0.18
c1	0.12	0.127	0.134
D	15.80	16.00	16.20
D1	13.90	14.00	14.10
E	15.80	16.00	16.20
E1	13.90	14.00	14.10
e	0.40BSC		
L	0.45	0.60	0.75
L1	1.00REF		
L2	0.25BSC		
R1	0.08	—	—
R2	0.08	—	0.20
S	0.20	—	—
θ	0°	3.5°	7°
$\theta 1$	0°	—	—
$\theta 2$	11°	12°	13°
$\theta 3$	11°	12°	13°

NOTES:
ALL DIMENSIONS REFER TO JEDEC STANDARD MS-026 BEE DO NOT INCLUDE MOLD FLASH OR PROTRUSIONS.

4 Version History

Version	Date	Changes
V1.0.0	2024.11.12	Initial release

5 Disclaimer

This document is the exclusive property of NSING TECHNOLOGIES PTE. LTD. (Hereinafter referred to as NSING). This document, and the product of NSING described herein (Hereinafter referred to as the Product) are owned by NSING under the laws and treaties of Republic of Singapore and other applicable jurisdictions worldwide. The intellectual properties of the product belong to Nations Technologies Inc. and Nations Technologies Inc. does not grant any third party any license under its patents, copyrights, trademarks, or other intellectual property rights. Names and brands of third party may be mentioned or referred thereto (if any) for identification purposes only. NSING reserves the right to make changes, corrections, enhancements, modifications, and improvements to this document at any time without notice. Please contact NSING and obtain the latest version of this document before placing orders. Although NATIONS has attempted to provide accurate and reliable information, NATIONS assumes no responsibility for the accuracy and reliability of this document. It is the responsibility of the user of this document to properly design, program, and test the functionality and safety of any application made of this information and any resulting product. In no event shall NATIONS be liable for any direct, indirect, incidental, special, exemplary, or consequential damages arising in any way out of the use of this document or the Product. NATIONS Products are neither intended nor warranted for usage in systems or equipment, any malfunction or failure of which may cause loss of human life, bodily injury or severe property damage. Such applications are deemed, 'Insecure Usage'. Insecure usage includes, but is not limited to: equipment for surgical implementation, atomic energy control instruments, airplane or spaceship instruments, all types of safety devices, and other applications intended to supporter sustain life. All Insecure Usage shall be made at user's risk. User shall indemnify NATIONS and hold NATIONS harmless from and against all claims, costs, damages, and other liabilities, arising from or related to any customer's Insecure Usage Any express or implied warranty with regard to this document or the Product, including, but not limited to. The warranties of merchantability, fitness for a particular purpose and non-infringement are disclaimed to the fullest extent permitted by law. Unless otherwise explicitly permitted by NATIONS, anyone may not use, duplicate, modify, transcribe or otherwise distribute this document for any purposes, in whole or in part.